



Model:
Eclipse

QUICK START GUIDE

For a full explanation of all features and instructions, please refer to the User's Guide (available for download from support.hubbleconnected.com).

1. Contents Inside Box



Eclipse

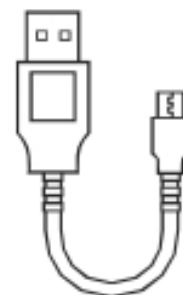

USB Charging Cable



Quick Start Guide

WARNING

Strangulation hazard. Children have STRANGLED on cords. Keep this cord out of the reach of children (more than 3 feet away).

2. Overview of Product

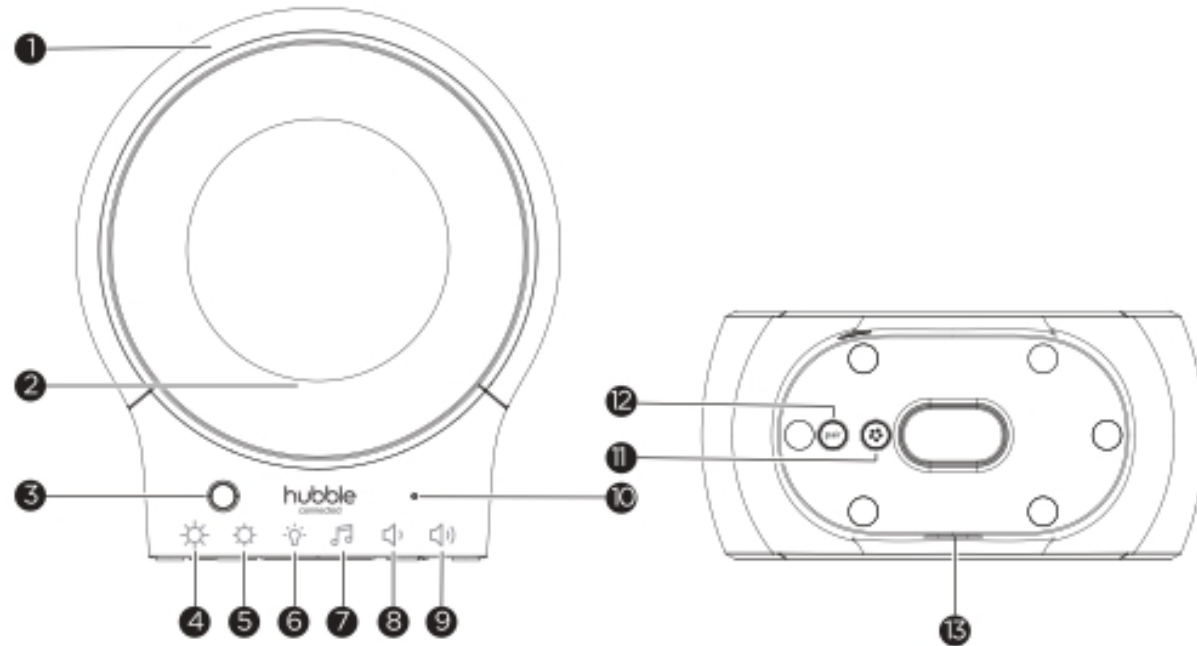

1. Night Light
2. Speaker
3. Light Sensor
4. Brightness Up key
5. Brightness Down key
6. Night Light key
7. Soothing Sound key

8. Volume Down key
9. Volume Up key
10. Microphone
11. Hubble Pair button
12. Bluetooth Pair button
13. Power Socket

3. Getting Start

3.1. Power on Eclipse

Connect Eclipse through the USB charging cable provided with a 5V 2A power adaptor (not included).





3.2. Connect to HubbleClub





- Scan the QR code with your smart device and download HubbleClub by Hubble Connected App from the App Store for iOS devices or from the Google Play™ Store for Android™ devices.
- Install HubbleClub by Hubble Connected App on your device.
- Press Hubble Pair  button at the bottom of Eclipse.
- The LED indicator blinks in blue for 180s at pairing mode.
- Follow the instructions of HubbleClub App to create your HubbleClub account.
- Select **Wellness** and then **Eclipse**, follow the in-app instructions to connect Hubble Eclipse to your account.
- If registration fails or connection cannot be completed during 180s, connection mode will be turned off.
- If registration fails, please try again by going through Step 1 to Step 4.
- Full control and full features can be accessed with HubbleClub App.

4. Basic Operation of Eclipse

4.1. Control Night Light

- Tap Night Light  icon at the front of Eclipse will change the colour of night light. The colour changes in cycle.
- The brightness of night light can be adjusted by tap brightness up  and brightness down  icons.

4.2. Control Soothing Sound

- Tap Soothing Sound  icon at the front of Eclipse will change the soothing sound.
- The volume of the soothing sound can be adjusted by tap volume up  and volume down  icons.

4.3. Use Eclipse as a Bluetooth Speaker

- Press Bluetooth Pair  button at the bottom of Eclipse to enter into pairing mode. The LED will blink in blue.
- Go to the Set-Up menu of your mobile phone. Then go to Bluetooth Connection.
- Find the Device name "Hubble Eclipse" and connect.
- If the connection fails, please try again by going through steps 1 to 3.
- Stream the audio from your mobile phone and listen to it in Eclipse.

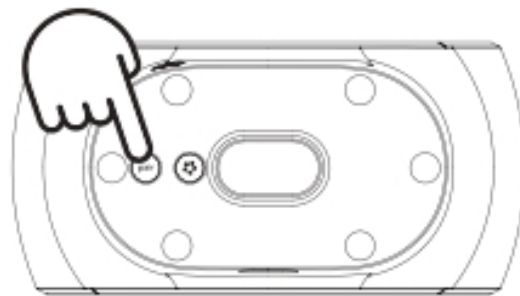

Note:

Once Bluetooth is disconnected, reactive Bluetooth by long pressing Bluetooth Pair  button, and reconnect Eclipse on your mobile phone.

5. General Information

If your product is not working properly, read this Quick Start Guide or the online User's Guide.

Contact Customer Service:

Live Chat: hubbleconnected.com

Email: support@hubbleconnected.com

Online warranty registration: <https://hubbleconnected.com/warranty>

Online Product Registration: <https://hubbleconnected.com/apps/product-registration>

Consumer Products and Accessories Limited Warranty ("Warranty")

Thank you for purchasing this Hubble Smart Nursery branded product manufactured by Hubble Baby (HK) Limited ("HUBBLE").

What Does this Limited Warranty Cover?

Subject to the items listed below in the section "What is not Covered" HUBBLE warrants that this Hubble connected branded product ("Product") will be free from defects in material and workmanship under normal use for a period of 1 year from the date of purchase and that any certified accessory ("Accessory") sold for use with this product will be free from defects in materials and workmanship under normal use for a period of 90-days from the date of purchase. This Limited Warranty is your exclusive warranty and is not transferable.

What is not covered?

This Limited Warranty excludes and does not cover:

- Normal deterioration or wear resulting from use;
- Damage caused by or resulting from misuse, abuse, or accident;
- Damage caused by or resulting from improper operation or storage;
- Damage caused by or resulting from contact with foreign substances, including, but not limited, to liquid, water, rain, humidity, perspiration, sand, dirt, and/or food;
- Damage caused by or resulting from the use of Non-Hubble Smart Nursery branded or certified Products or Accessories or other peripheral equipment;

-
- Damage caused by or resulting from modifications, alterations, tampering, improper installation, or repairs by someone other than Hubble connected or their authorized representatives;
 - Defects, damages, or the failure of Products or Accessories due to any communication service or signal you may subscribe to or use with the Products or Accessories; and,
 - Periodic maintenance, repair and replacement of parts due to normal wear and tear.

What Other Limitations Are There?

THIS LIMITED WARRANTY SETS FORTH THE ENTIRE LIABILITY OF HUBBLE AND CONTAINS YOUR SOLE AND EXCLUSIVE REMEDY. OTHER THAN THIS LIMITED WARRANTY, HUBBLE MAKES NO ADDITIONAL REPRESENTATIONS OR WARRANTIES, EXPRESS OR IMPLIED, INCLUDING WARRANTIES OF MERCHANTABILITY OR FITNESS FOR A PARTICULAR PURPOSE. IF YOUR STATE DOES NOT PERMIT THE DISCLAIMER OF WARRANTIES, THEN THE IMPLIED WARRANTY OF MERCHANTABILITY AND FITNESS FOR A PARTICULAR PURPOSE IS LIMITED TO THE DURATION OF THIS LIMITED WARRANTY. REPAIR OR REPLACEMENT IS YOUR SOLE AND EXCLUSIVE REMEDY AGAINST HUBBLE AND Hubble Smart Nursery. IN NO EVENT SHALL HUBBLE OR Hubble Smart Nursery's LIABILITY TO REPAIR OR REPLACE YOUR PRODUCT OR ACCESSORY EXCEED THE ORIGINAL PURCHASE PRICE OF THE PRODUCT AND ACCESSORY AND HUBBLE AND Hubble Smart Nursery's TOTAL LIABILITY FOR DAMAGES ARISING FROM THIS LIMITED WARRANTY SHALL NOT EXCEED THE PRICE YOU PAID FOR THE PRODUCT AND ACCESSORY REGARDLESS OF WHETHER SUCH CLAIM ARISES UNDER CONTRACT, STATUTE, TORT OR OTHERWISE. IN NO EVENT AND UNDER NO CIRCUMSTANCES WILL HUBBLE OR Hubble Smart Nursery BE LIABLE FOR DIRECT, INDIRECT, INCIDENTAL, SPECIAL OR CONSEQUENTIAL DAMAGES OF ANY KIND, OR LOSS OF REVENUE OR PROFITS, LOSS OF BUSINESS, LOSS OF INFORMATION OR OTHER FINANCIAL LOSS ARISING OUT OF OR IN CONNECTION WITH THE ABILITY OR INABILITY TO USE THE PRODUCTS OR ACCESSORIES. ALL DISCLAIMERS, LIMITATIONS OF LIABILITY AND MODIFICATIONS OF WARRANTIES STILL APPLY EVEN IF THE LIMITED REMEDY OF REPAIR AND REPLACEMENT FAILS OF ITS ESSENTIAL PURPOSE.

Some jurisdictions do not allow the limitation or exclusion of incidental or consequential damages, so the above limitations or exclusions may not apply to you. This Limited Warranty gives you specific legal rights, and you may have other rights that vary from one jurisdiction to another.

Who is covered?

This Warranty extends only to the first consumer purchaser and is not transferable.

What will HUBBLE do?

HUBBLE or its authorized distributor at its sole discretion will, at no charge, repair or replace any Products or Accessories that do not conform to this Warranty. In the event that replacement is necessary to remedy a defect in material or workmanship, HUBBLE may use new or remanufactured products, accessories or parts of equal quality to the original Product or Accessory.

How to Obtain Warranty Service or Other Information?

To obtain service or information:

Live Chat: hubbleconnected.com

Email: support@hubbleconnected.com

Online warranty registration: <https://hubbleconnected.com/warranty>

Online Product Registration: <https://hubbleconnected.com/apps/product-registration>

You will receive instructions on how to ship the Products or Accessories at your expense and risk, to a HUBBLE Authorized Repair Center.

You must include: (a) the Product or Accessory; (b) the original proof of purchase (receipt) which includes the date, place and seller of the Product; (c) if a warranty card was included in your box, a completed warranty card showing the serial number of the Product; (d) a written description of the problem; and, (e) your name, address, email address and telephone number. These terms and conditions constitute the complete warranty agreement between you and HUBBLE regarding the Products or Accessories purchased by you, and supersede any prior agreement or representations, including representations made in any literature publications or promotional materials issued by HUBBLE or representations made by any agent, employee or staff of HUBBLE, that may have been made in connection with your purchase of any Product and/or Accessory.

FCC and IC regulations (FCC Part 15)

NOTE: This equipment has been tested and found to comply with the limits for a Class B digital device, pursuant to Part 15 of the Federal Communications Commission (FCC) rules.

Industry Canada. This device complies with Industry Canada license-exempt RSS standard(s):

Operation is subject to the following Two conditions:(1) this device may not cause interference, and (2) this device must accept any interference, including interference that may cause undesired operation of the device.

Download User Guide from website: support.hubbleconnected.com



Manufactured, distributed and sold by Hubble Baby (HK) Limited. Apple logo is trademark of Apple Inc., registered in the U.S. and other countries. App Store is a service mark of Apple Inc. Google Play and Android are trademarks of Google Inc. Wi-Fi is a trademark of the Wi-Fi Alliance. All rights reserved.

Printed in China
US_EN Version 3.0

